

# INSTANT UPRIGHT

## Span 400 Advance Guard Rail System Instruction Manual



DESIGNATION  
SPAN 400 AGR Double Width  
EN 1004 – 3 – 8/12 – XXCD-H2  
SPAN 400 AGR Single Width  
EN 1004 – 3 – 8/8 – XXCD-H2

CEN designation of this instruction manual  
EN 1004-2 – IM – en  
Rev-00

EN 1004-1:2020



## SAFE WORKING LOADS AND WORKING HEIGHTS

The safe working load at each level of platform is 360kg evenly distributed, regardless of whether one or two platforms are installed. Therefore, even if two platforms are installed side by side, total cumulative load shall not exceed 360kg distributed.

The total loading on the tower structure should not exceed 720kg. Normal maximum platform height for indoor use is 12m for Double Width, and 8m for Single Width. For outdoor use, the maximum height is 8m for Single and Double Widths.

Only one platform may be loaded at any one time.

### ASSEMBLY PROCESS

#### 1. Preparation

- Locate the tower level adjusters on each leg at 10cm (4 inches) from the bottom of the leg.
- Unlock the interlock clips on all frames.
- When installed, always move the interlock clip to the “locked” position.
- Sort the braces into horizontal and diagonal braces - the diagonals are slightly longer.
- Unlock the brace locks.

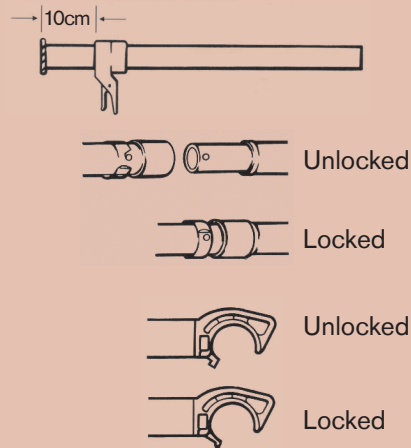

#### 2. Base

Step 1: Install castor into adjustable leg.

Step 2: Ensure interlock clips are released from the base frames (bottom frames).

Step 3: Install castor / leg assembly to frame by pushing the leg into the frame tube. This should be done with manual force only, no tools.

Step 4: Lock castors before ascending any part of the tower.

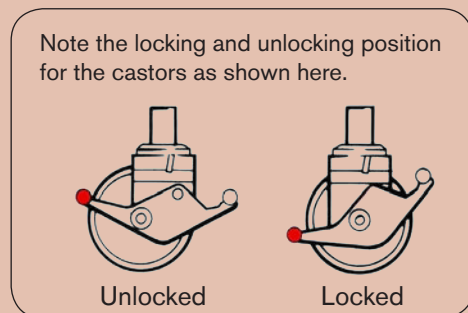

#### 3. Locking down the platform (Windlock)

A windlock clip is installed on the platform at the hook. This is locked as shown here.

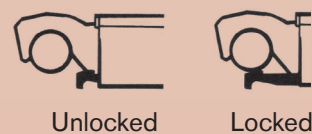

## USAGE ADVICE

- We recommend a minimum of two people to assemble, dismantle and move the platform tower.
- Check that all components are on site and in good working order.
- Ensure that the assembly location is checked to prevent hazards during assembly, dismantling or moving and while working on the tower. Particular attention should be given to the ground condition, whether level or sloping, obstructions and wind conditions. The ground condition must be capable of supporting the tower structure.
- Towers must always be climbed from the inside of the assembly using the ladder.
- Adjustable legs must only be used to level the tower.
- If the adjustable legs are to be extended by more than 150 mm; a risk assessment needs first to be undertaken by a competent person.
- Lifting of components must be done inside the effective base area of the tower; components are normally hoisted using a rope.
- Moving the tower must only be done by manual effect from the base of the tower.
- When moving tower be aware of overhead hazards (e.g. electric cables).
- No personnel or material to be on the platform whilst the tower is being moved.
- Beware of horizontal loads which can lead to instability of the tower. The maximum side force is 20kg.
- When tying-in the tower, attach a tie to each upright at 4m height intervals. Ensure that couplers are suitable for 50mm diameter aluminum tube.
- Do not use boxes or steps to gain additional height. If extra height required, contact your distributor to get extra components.
- Do not lift or suspend an assembled mobile tower.
- Damaged components or components from other tower systems must never be used.
- Stabilisers should always be fitted when specified. Use the stabiliser shown on the component list according to the tower height.
- When wind exceeds Beaufort force 4, cease using the tower.
- If wind is expected to reach Beaufort force 6, tie tower to a rigid structure.
- If winds of Force 8 are forecast, dismantle the tower or remove to shelter.

### Wind speeds

Force	Peak mph	Peak km/h	Peak m/s	Guidance
4	18	29	8.1	Moderate breeze - raises dust & loose paper
6	31	50	13.9	Strong breeze - difficult to use umbrella
8	48	74	20.8	Gale force - walking is difficult

## CARE AND MAINTENANCE

- Keep all equipment clean, especially spigots and sockets where frames join. Spigots should fit easily into sockets. Lubricate with light oil.
- Remove dirt or paint from adjustable legs with a light brush, lightly oil the leg locks.
- Do not strike or hammer components. Do not throw or drop onto hard surfaces.
- Lightly oil spring mechanism of the hooks.
- For transport and storage, components are best stored vertically.
- Damaged parts must be repaired or replaced; refer to the Instant Upright website for further advice or contact your equipment supplier for advice.

## MOVING AGR TOWERS

**To Move the tower to a new position, first prepare the tower.**

- Check that the wind speed does not exceed 29km/h (8.1m/s).
- Ensure the tower is empty (material and personnel).
- Check for overhead obstructions including electrical cables.
- Raise the stabiliser feet (only enough to clear obstructions).
- Taking care to ensure tower stability is maintained, insert any extended adjustable legs completely into the frame.
- Release the castor brakes.
- Carefully move the tower by manually applying force at the base. Do not use mechanical means to move the tower.
- Once positioned prepare the tower for use.
- Check and adjust as necessary to ensure all castors and stabilisers are in firm contact with the ground.
- Check that the tower is vertical using a spirit level.
- Reapply the castor brakes.

### ADVANCE GUARD RAIL (AGR) FITTING



AGR-1



AGR-2

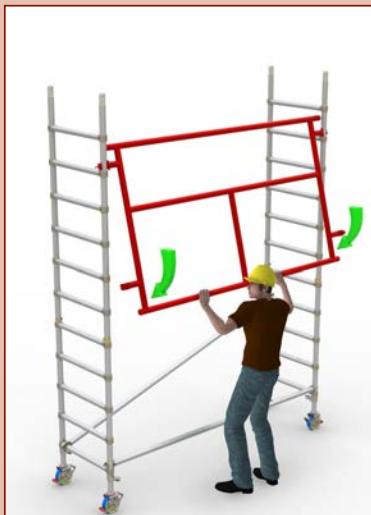

AGR-3

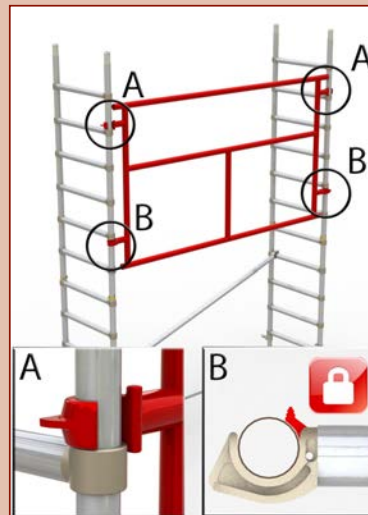

AGR-4

## STABILISERS

Stabilisers are to be used, when specified, to guarantee the structural stability of the tower.

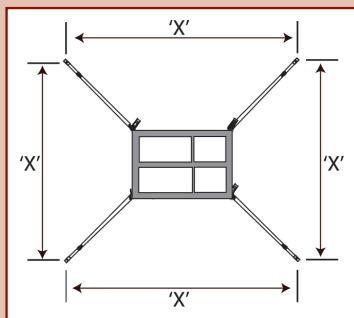
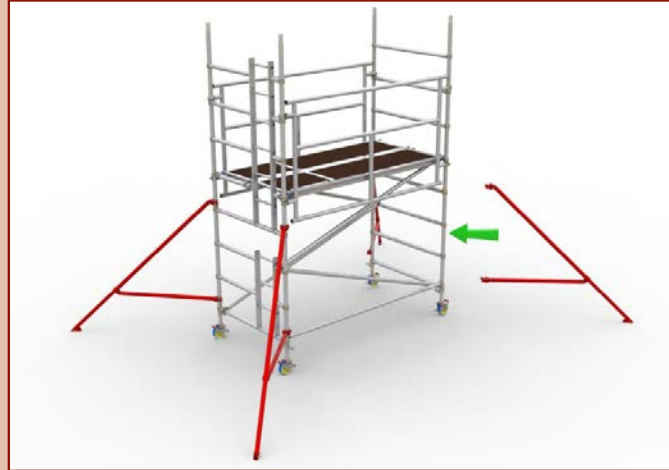

Fig 2

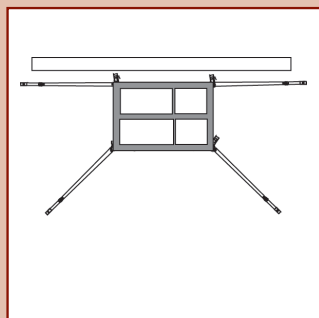

Fig 3

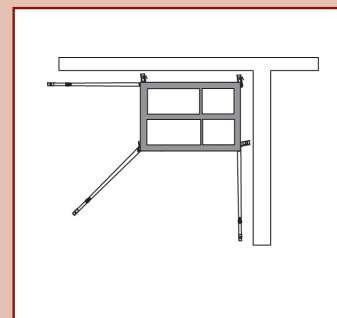

Fig 4

	2m single platform	2.5m single platform	3m single platform
Telescopic Stabiliser	x = 3730mm	x = 3929mm	x = 4078mm
Large Stabiliser	x = 4440mm	x = 4660mm	x = 4841mm
	2m double platform	2.5m double platform	3m double platform
Telescopic Stabiliser	x = 4095mm	x = 4333mm	x = 4523mm
Large Stabiliser	x = 4792mm	x = 5042mm	x = 5252mm

### ALWAYS ENSURE STABILISER SIZE IS CORRECT AND ABLE TO SUPPORT TOWER

Lightly tighten the upper clamps above the sixth rung on each corner post. Position the lower clamp above the bottom rung. Ensure the lower arm is as horizontal as possible. Position the stabilisers so that the footpads are approximately equidistant from each other, as shown in Fig.2. Adjust the stabiliser and reposition the clamps as required to make firm contact with the ground. Ensure the clips with locking pin are in place. When in the correct position, tighten the clamps firmly.

To position the tower against a wall, do not remove the stabiliser; move parallel with the wall. (Fig.3)

To position the tower in a corner, remove the inside stabiliser and place the outside two parallel with the wall. (Fig.4)

## SPECIFIC PRODUCT INFORMATION

Table of parts and quantities

Span 400 AGR Double Width Towers - 2m, 2.5m and 3m lengths to EN1004 and WAHR									
Platform Height (m)	2m	4m	6m	8m	10m	12m			
Work Height (m)	4	6	8	10	12	14			
Tower Height (m)	3	5	7	9	11	13			
Tower Weight in kg (2m length)	125	191	256	328	392	460			
Tower Weight in kg (2.5m length)	138	213	288	370	443	520			
Tower Weight in kg (3m length)	149	231	314	402	482	567			
Note: Quoted platform heights included 150mm leg adjustment for levelling that can be increased or reduced									
Description	Weight (kg)			Quantity Required					
5 Rung Frame	9.3			1	2	3	4	5	6
5 Rung Ladder Frame	12.6			1	1	1	1	1	1
3 Rung Frame	5.8			1	2	3	4	5	6
3 Rung Ladder Frame	7.2			1	1	1	1	1	1
Trapdoor Platform	14	18	20	1	2	3	4	5	6
Fixed Platform	14	17	20	1	2	3	4	5	6
Horizontal Brace	1.7	2	2.4	1	1	1	1	1	1
Diagonal Brace	1.8	2.2	2.5	2	3	4	5	6	7
Advance Guardrail	7	8	9	2	4	6	8	10	12
Telescopic Stabiliser (50430)	5.2			4	4	4			
Large Stabiliser (9090)	6.8						4	4	4
Adjustable Legs	1.1			4	4	4	4	4	4
Castor / Baseplate	2.2			4	4	4	4	4	4
Toe-board set	8.7	11.5	14.4	1	1	1	1	1	1



**DOUBLE-WIDTH TOWER 6m**

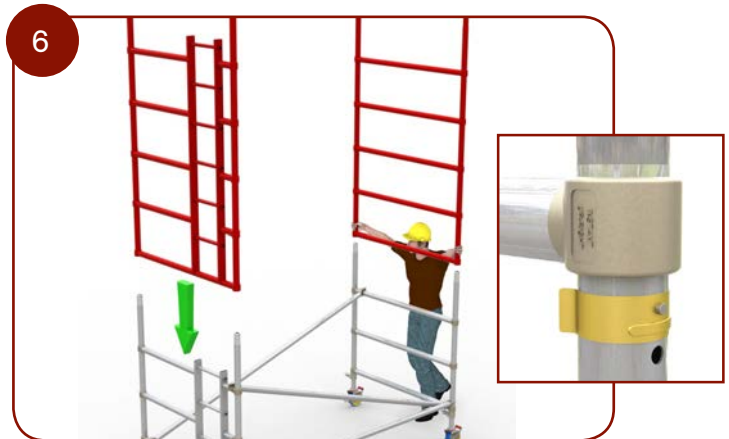
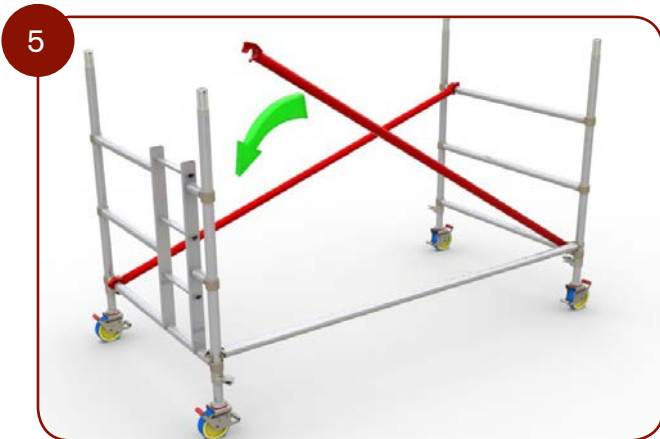
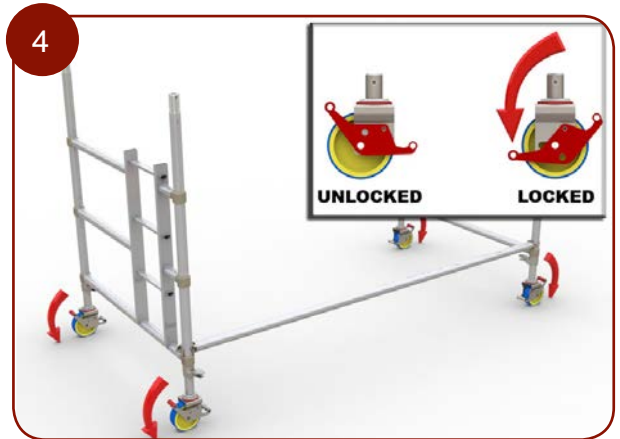
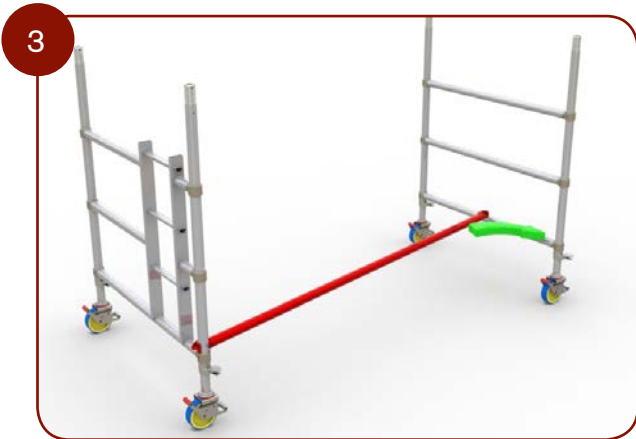
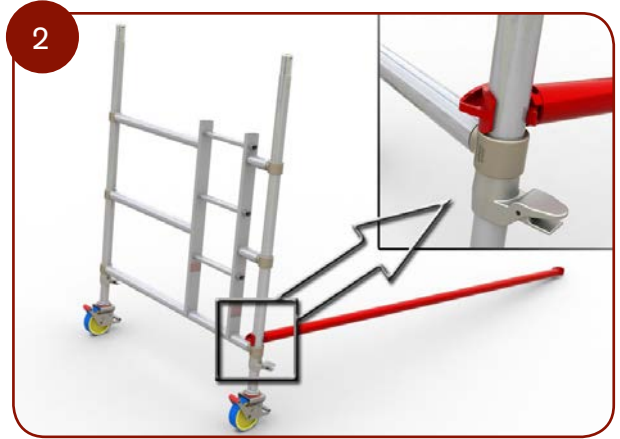
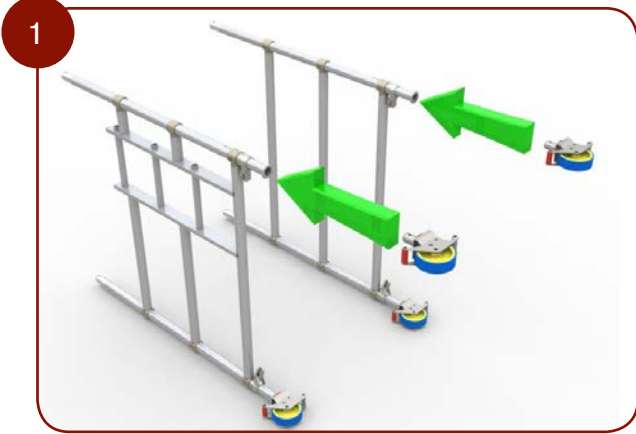

**DOUBLE-WIDTH TOWER 6m**

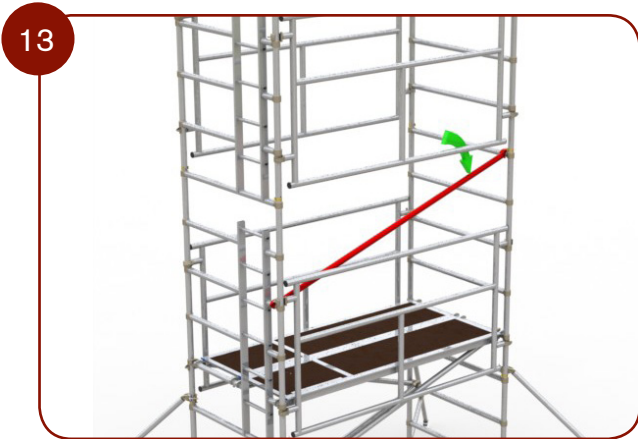
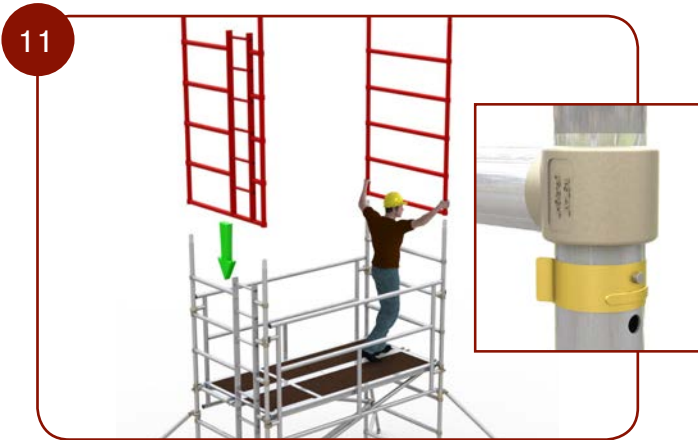
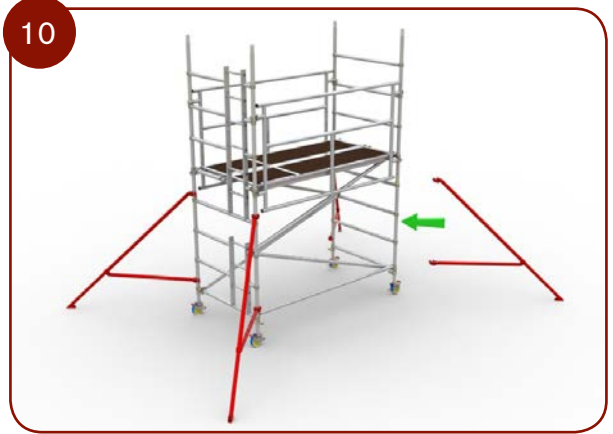



---

**DOUBLE-WIDTH TOWER 6m**

17



## SPECIFIC PRODUCT INFORMATION

Table of parts and quantities

Span 400 AGR Single Width Towers - 2m, 2.5m and 3m lengths to EN1004 and WAHR								
Platform Height (m)	2m		4m		6m		8m	
Work Height (m)	4		6		8		10	
Tower Height (m)	3		5		7		9	
Tower Weight in kg (2m length)	102		150		198		252	
Tower Weight in kg (2.5m length)	111		165		219		280	
Tower Weight in kg (3m length)	118		176		234		299	
Note: Quoted platform heights included 150mm leg adjustment for levelling that can be increased or reduced								
Description	Weight (kg)			Quantity Required				
5 Rung Frame	7.3			1	2	3	4	
5 Rung Ladder Frame	4.5			1	1	1	1	
3 Rung Frame	10.6			1	2	3	4	
3 Rung Ladder Frame	5.9			1	1	1	1	
Trapdoor Platform	14	18	20	1	2	3	4	
Horizontal Brace	1.7	2	2.4	1	1	1	1	
Diagonal Brace	1.8	2.2	2.5	2	3	4	5	
Advance Guardrail	7	8	9	2	4	6	8	
Telescopic Stabiliser (50430)	5.2			4	4	4		
Large Stabiliser (9090)	6.8						4	
Adjustable Legs	1.1			4	4	4	4	
Castor / Baseplate	2.2			4	4	4	4	
Toe-board set	6.8	8.4	9.8	1	1	1	1	

**SINGLE-WIDTH TOWER 6m**

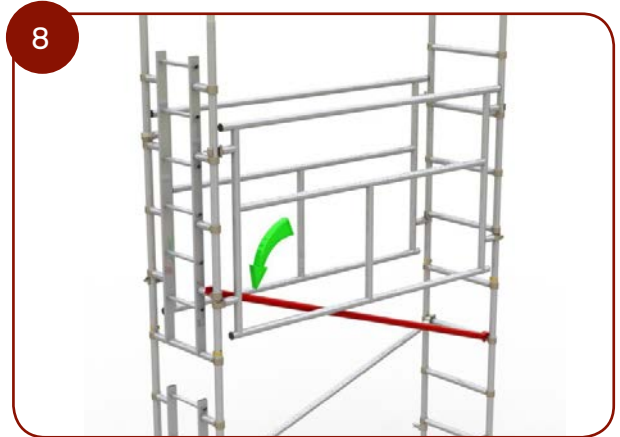
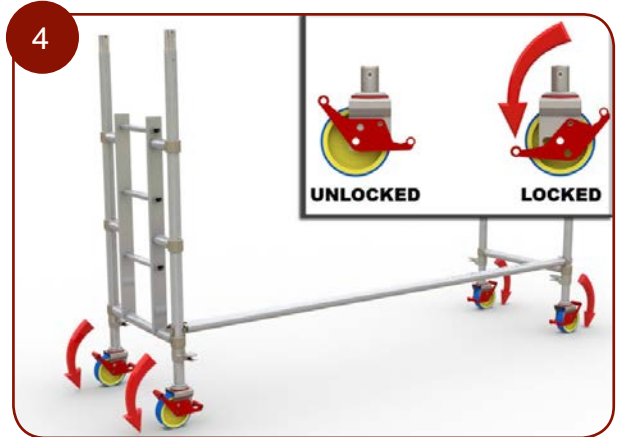
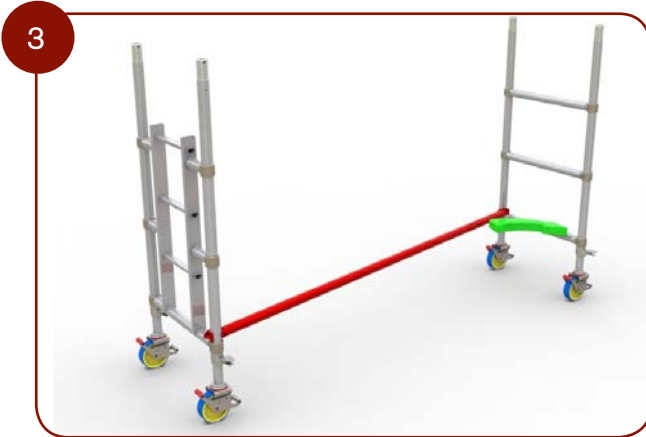
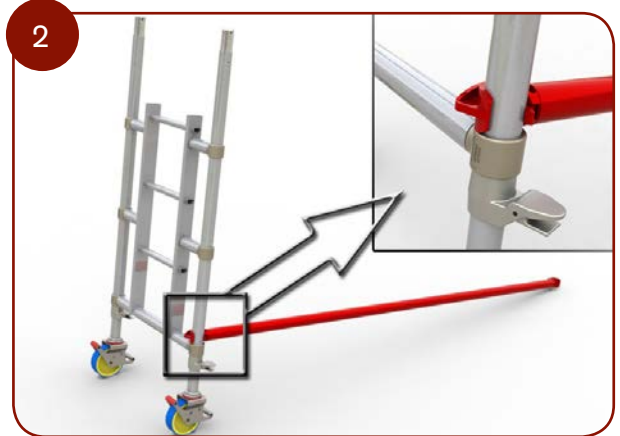
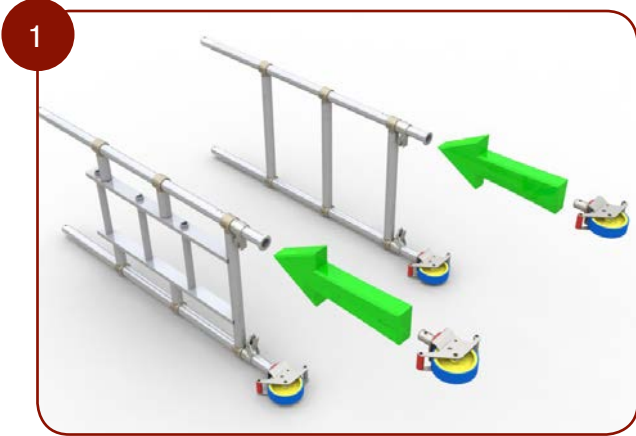

**SINGLE-WIDTH TOWER 6m**

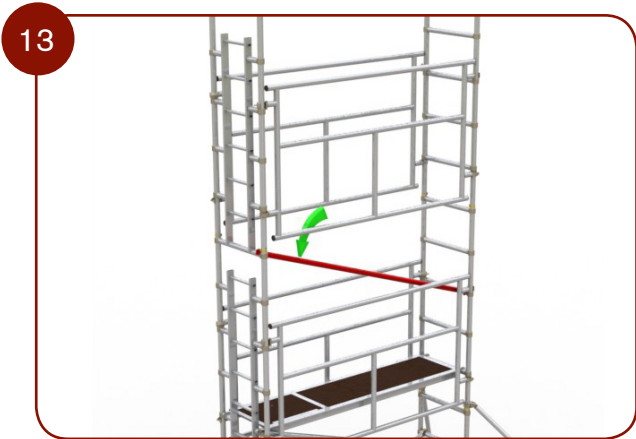
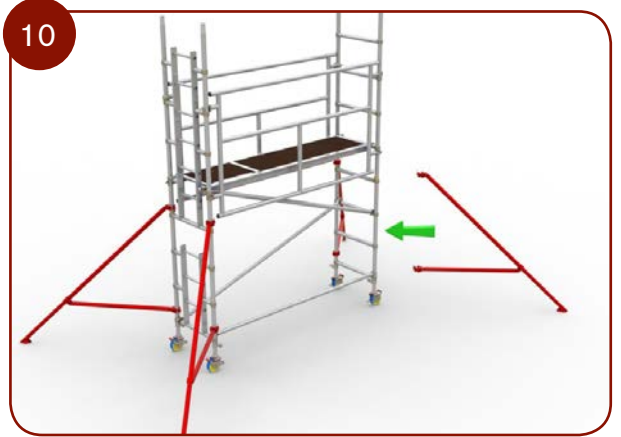

---

**SINGLE-WIDTH TOWER 6m**

17

