

INSTANT UPRIGHT

Span 300 Series Instruction Manual



DESIGNATION

SPAN300 Double Width
EN1004 - 3 - 8/12 - XXCD - H2
SPAN 300 Single Width
EN 1004 - 3 - 8/8 - XXCD - H2

300W Double Width
EN 1004 - 3 - 8/12 - XXCD - H2
300W Single Width
EN 1004 - 3 - 8/8 - XXCD - H2

CEN designation of this instruction manual
EN 1004-2-IM-EN
Rev-0

EN 1004-1:2020



SAFE WORKING LOADS AND WORKING HEIGHTS

The safe working load at each level of platform is 360kg evenly distributed, regardless of whether one or two platforms are installed. Therefore, even if two platforms are installed side by side, total cumulative load shall not exceed 360kg distributed.

The total loading on the tower structure should not exceed 720kg. Normal maximum platform height for indoor use is 12m for Double Width, and 8m for Single Width. For outdoor use, the maximum height is 8m for Single and Double Widths.

Only one platform may be loaded at any one time.

ASSEMBLY PROCESS

1. Preparation

- Locate the tower level adjusters on each leg at 10cm (4 inches) from the bottom of the leg.
- Unlock the interlock clips on all frames.
- When installed, always move the interlock clip to the “locked” position.
- Sort the braces into horizontal and diagonal braces - the diagonals are slightly longer.
- Unlock the brace locks.

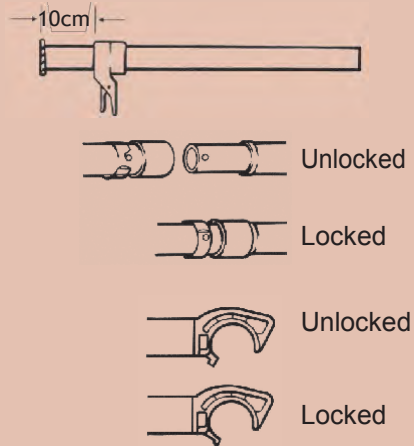

2. Base

- Step 1: Install castor into adjustable leg.
- Step 2: Ensure interlock clips are released from the base frames (bottom frames).
- Step 3: Install castor / leg assembly to frame by pushing the leg into the frame tube. This should be done with manual force only, no tools.
- Step 4: Lock castors before ascending any part of the tower.

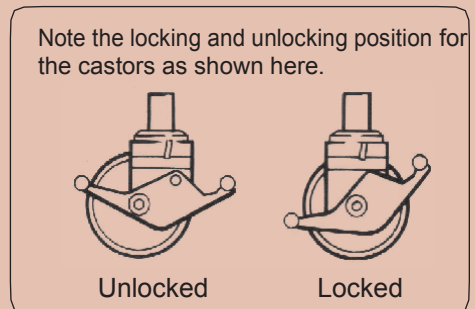

3. Locking down the platform (Windlock)

A windlock clip is installed on the platform at the hook. This is locked as shown here.

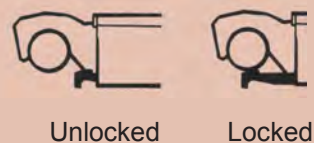

USAGE ADVICE

- We recommend a minimum of two people to assemble, dismantle and move the platform tower.
- Check that all components are on site and in good working order.
- Ensure that the assembly location is checked to prevent hazards during assembly, dismantling or moving and while working on the tower. Particular attention should be given to the ground condition, whether level or sloping, obstructions and wind conditions. The ground condition must be capable of supporting the tower structure.
- Towers can be climbed from the inside of the assembly using the ladder.
- Adjustable legs must only be used to level the tower and leg extension must be minimised before the tower is moved (max 150mm).
- Lifting of components must be done inside the effective base area of the tower; components are normally hoisted using a rope.
- Moving the tower must only be done by manual effect from the base of the tower.
- When moving tower be aware of overhead hazards (e.g. electric cables).
- No personnel or material to be on the platform whilst the tower is being moved.
- Beware of horizontal loads which can lead to instability of the tower. The maximum side force is 20kg.
- When tying-in the tower, attach a tie to each upright at 4m height intervals. Ensure that couplers are suitable for 50mm diameter aluminum tube.
- Do not use boxes or steps to gain additional height. If extra height required, contact your distributor to get extra components.
- Do not lift or suspend an assembled mobile tower.
- Damaged components or components from other tower systems must never be used.
- Stabilisers should always be fitted when specified. Use the stabiliser shown on the component list according to the tower height.
- When wind exceeds Beaufort force 4, cease using the tower.
- If wind is expected to reach Beaufort force 6, tie tower to a rigid structure.
- If winds of Force 8 are forecast, dismantle the tower or remove to shelter.

Wind speeds				
Force	Peak mph	Peak km/h	Peak m/s	Guidance
4	18	29	8.1	Moderate breeze - raises dust & loose paper
6	31	50	13.9	Strong breeze - difficult to use umbrella
8	48	74	20.8	Gale force - walking is difficult

CARE AND MAINTENANCE

- Keep all equipment clean, especially spigots and sockets where frames join. Spigots should fit easily into sockets. Lubricate with light oil.
- Remove dirt or paint from adjustable legs with a light brush, lightly oil the leg locks.
- Do not strike or hammer components. Do not throw or drop onto hard surfaces.
- Lightly oil spring mechanism of the hooks.
- For transport and storage, components are best stored vertically.
- Damaged parts should be repaired or replaced. Contact your equipment supplier for advice.

DISMANTLING / MOVING TOWERS

To dismantle, follow the build process but in reverse order noting the following.

- To remove the guardrail frames or braces, first unlock the hook at the end away from the trapdoor.
- Sitting through the trapdoor, unlock the near end hook and remove the brace.

To Move the tower to a new position, first prepare the tower.

- Wind speed should not exceed 29 km/h (8.1 m/s).
- Ensure leg extension is minimised (Max 150mm) Release the castor brakes.
- Raise the stabiliser feet only enough to clear obstructions.
- Ensure tower is empty (material and personnel).
- Check for overhead obstructions including electrical wires.
- Move the tower manually by applying force at the base - do not use machinery to push or pull the tower.
Once moved - prepare the tower for use.
- Check all castors and stabilisers are in firm contact with the ground.
- Check tower is vertical (spirit level) and adjust legs as required.
- Reapply the castor brakes.

3-T SAFETY STANDARD - THROUGH THE TRAP

This is an approved method of tower construction which, if carried out by a competent person, complies with current safety legislation.

Construction- basic principles

- Always install the trapdoor over the ladder (if one is fitted).
- Ensure the trapdoor hinges to the outside of a double width tower (not to the center).
- Once the platform has been installed, climb, using the approved method and sit in the trapdoor opening.
- While seated, attach horizontal braces to the frames to form guardrails on both sides of the platform.
- See assembly instructions for specific placement of guardrails.
- 2 braces are normally required each side, although bracing frames can be used on the outside if desired or specified in the instructions.
- Only when the platform is fully guarded is it safe to stand up on the platform.

Dismantling

- Unlock the brace ends furthest away from the trapdoor.
- Sit through the trapdoor as per Fig.1
- Do not remove braces until sitting in the trapdoor.
- NEVER STAND ON AN UNGUARDED PLATFORM.



Fig 1

STABILISERS

Stabilisers are to be used, when specified, to guarantee the structural stability of the tower. In addition, the ballast table is to be observed.

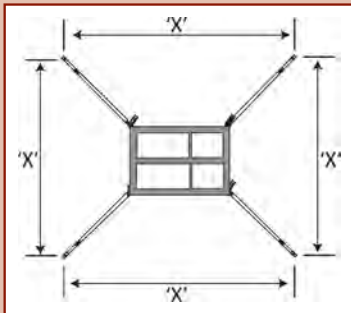

Fig 2



Fig 3



Fig 4

	2m single platform	2.5m single platform	3m single platform
Telescopic Stabiliser	x = 3730mm	x = 3929mm	x = 4078mm
Large Stabiliser	x = 4440mm	x = 4660mm	x = 4841mm
	2m double platform	2.5m double platform	3m double platform
Telescopic Stabiliser	x = 4095mm	x = 4333mm	x = 4523mm
Large Stabiliser	x = 4792mm	x = 5042mm	x = 5252mm

ALWAYS ENSURE STABILISER SIZE IS CORRECT AND ABLE TO SUPPORT TOWER

Lightly tighten the upper clamps above the sixth rung on each corner post. Position the lower clamp above the bottom rung. Ensure the lower arm is as horizontal as possible. Position the stabilisers so that the footpads are approximately equidistant from each other, as shown in Fig.2. Adjust the outrigger and reposition the clamps as required to make firm contact with the ground. Ensure the clips with locking pin are in place. When in the correct position, tighten the clamps firmly.

To position the tower against a wall, do not remove the stabiliser; move parallel with the wall. (Fig.3)

To position the tower in a corner, remove the inside stabiliser and place the outside two parallel with the wall. (Fig.4)

ALTERNATIVE CONFIGURATIONS

This manual details the sequence for the building of towers with ladder frames and a single platforms up to the working level. Alternative builds may be adopted as follows:



2 platforms at every level

A second platform can be added (trapdoor not required) to each intermediate access platform level. (Double width towers only)

Fig 4.



Inclined ladder access

Inclined ladders can be fitted for access to each platform level. If inclined ladders are used, then ladder frames can be replaced by standard frames in the build tables.

(Suitable for both single and double width towers)

Fig 5.



Base Access Ladder

Optional base ladder access can be installed when platform is above 0.6m and easy access is required.

Fig 6

BUILD TABLE ADJUSTMENTS



If inclined ladders are used, then ladder frames can be replaced by standard frames in the following build tables

Fig 7

Single Width tower with inclined ladder access



If double width platforms are required at all levels, the number of standard platforms in the double width build table should be increased to match the number of trapdoor platforms

Fig 8

Double Width tower with 2 platforms at all levels and inclined ladder access

Span400 system shown in above graphics

For double width platform levels, height class may become H1. Reposition the platforms one rung higher or lower to achieve H2.

VERTICAL DISTANCE BETWEEN LEVELS

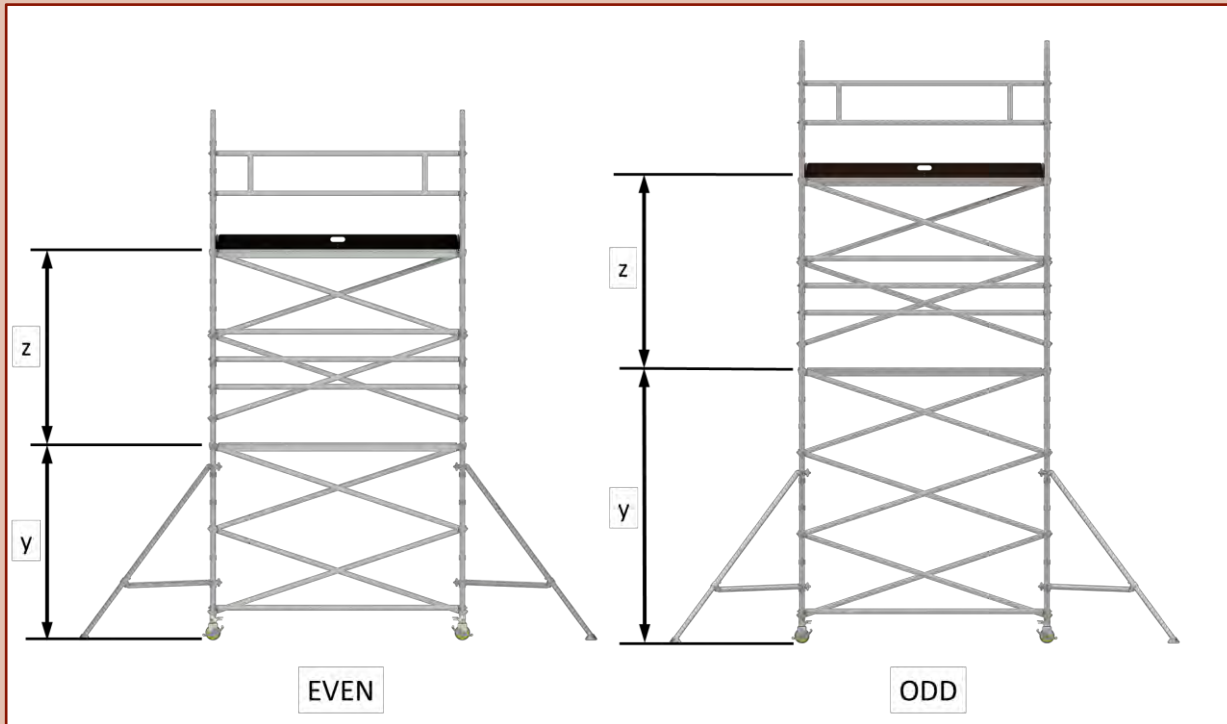

Span 300

	Even Tower Heights	Odd Tower Heights
Distance between platforms	$z = 1.94\text{m}$	$z = 1.94\text{m}$
Distance from ground to first platform	$y = 2.19\text{m}$	$y = 3.02\text{m}$

Span 300W

	Even Tower Heights	Odd Tower Heights
Distance between platforms	$z = 1.94\text{m}$	$z = 1.94\text{m}$
Distance from ground to first platform	$y = 2.30\text{m}$	$y = 3.13\text{m}$

Note, the stated distance from ground to first platform is based on a tower with 8" castor wheels and an adjustable leg extended to 150mm.

SPECIFIC PRODUCT INFORMATION

Table of parts and quantities

Span 300 Double Width Towers - 2m, 2.5m and 3m lengths to EN1004

Platform Height (m)	1m	2m	3m	4m	5m	6m	7m	8m	9m	10m	11m	12m
Work Height (m)	3	4	5	6	7	8	9	10	11	12	13	14
Tower Height (m)	2	3	4	5	6	7	8	9	10	11	12	13
Tower Weight in kg (2m in length) (SPAN300)*	106	127	153	180	193	234	253	294	307	348	361	402
Tower Weight in kg (2.5m in length) (SPAN300)*	118	140	171	201	215	262	282	330	343	391	405	452
Tower Weight in kg (3m in length) (SPAN300)*	129	151	186	217	233	284	306	357	373	424	439	491
* Weight reduction (kg) for 300W Towers	6	9	11	14	17	20	22	26	28	31	34	37

Note: Quoted platform heights included 150mm leg adjustment for leveling that can be increased or reduced

Description	Weight (kg)														
7 Rung Frame SPAN300 (300W)	11.2 (8.4)			2	2	4	4	6	6	8	8	10	10	12	12
4 Rung Frame SPAN300 (300W)	8.5 (6.9)				2		2		2		2		2		2
Trapdoor Platform (2, 2.5, 3m)	14	18	20	1	1	2	2	2	3	3	4	4	5	5	6
Fixed Platform (2, 2.5, 3m)	14	17	20	1	1	1	1	1	1	1	1	1	1	1	1
Horizontal Brace (2, 2.5, 3m)	1.7	2	2.4	1	1	3	7	9	13	15	19	21	25	27	31
Diagonal Brace (2, 2.5, 3m)	1.8	2.2	2.5	2	4	6	8	10	12	14	16	18	20	22	24
Telescopic Stabiliser (50430)	5.2			4	4	4	4	4	4						
Large Stabiliser (9090)	6.8									4	4	4	4	4	4
Adjustable Leg	1.1			4	4	4	4	4	4	4	4	4	4	4	4
Castor	2.2			4	4	4	4	4	4	4	4	4	4	4	4
Toe-board set (2, 2.5, 3m)	8.7	11.5	14.4	1	1	1	1	1	1	1	1	1	1	1	1
Bracing frame (2, 2.5, 3m)	3.8	4.4	5.2	2	2	2	2	2	2	2	2	2	2	2	2

Exploded diagram & reference list

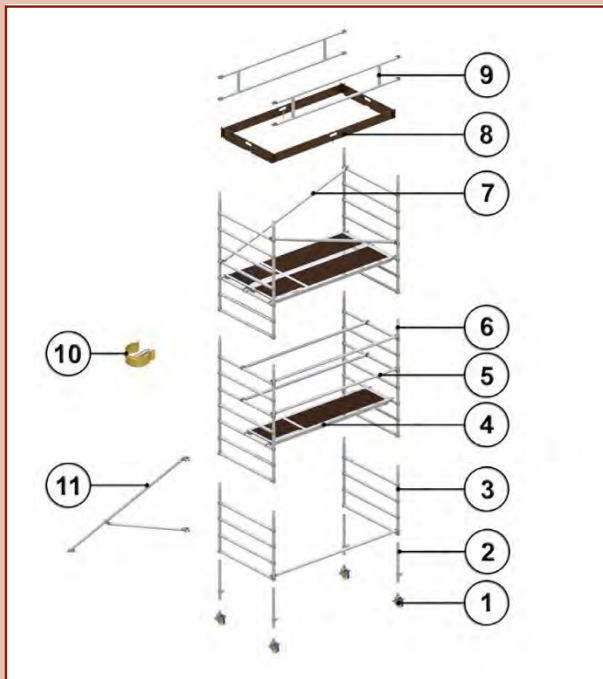

Tower Assembly

1. Castor
2. Adjustable Leg
3. 4 Rung Frame
4. Platform
5. Horizontal Brace
6. 7 Rung Frame
7. Diagonal Brace
8. Toeboard
9. Bracing Frame
10. Interlock Clip
11. Outrigger

DOUBLE-WIDTH TOWER 6m - BUILD SEQUENCES SHOWN USING THE SPAN300 (300W IS SAME)

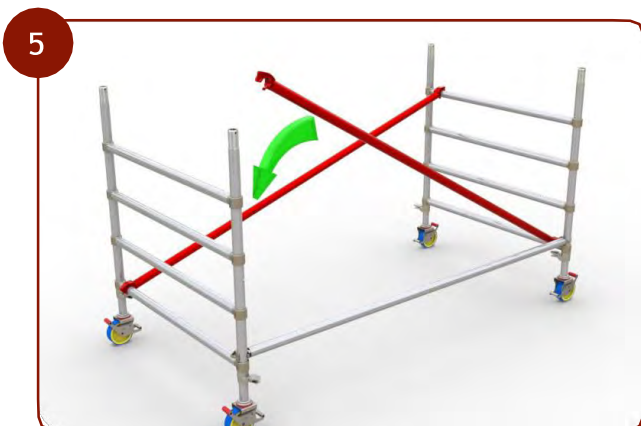
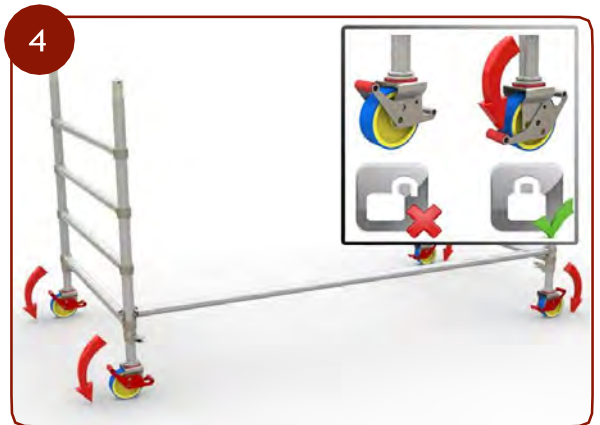
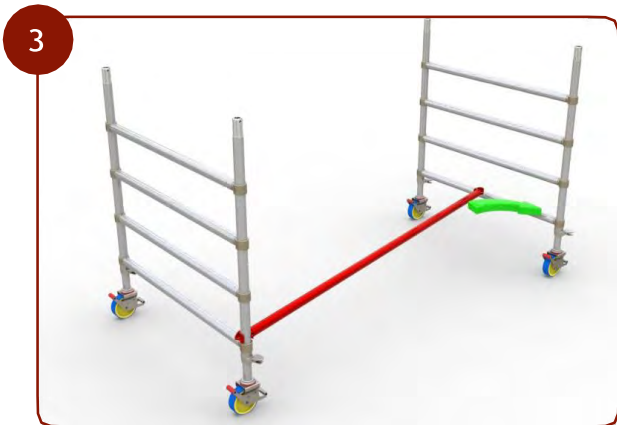
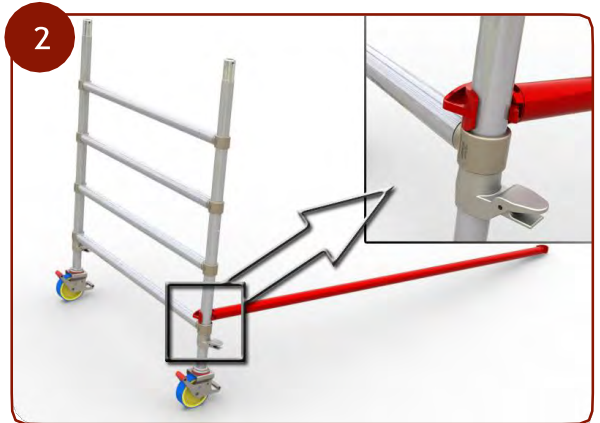
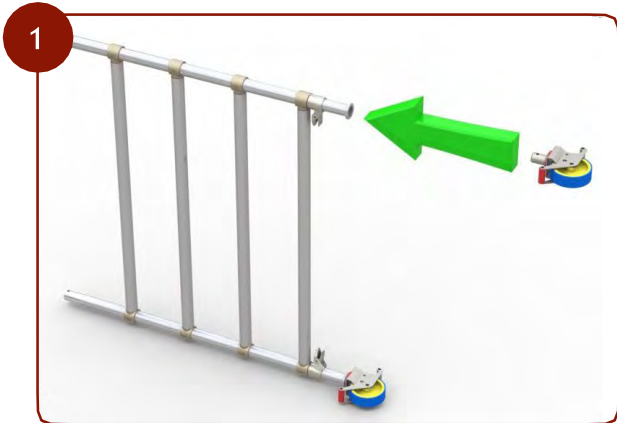

DOUBLE-WIDTH TOWER 6m

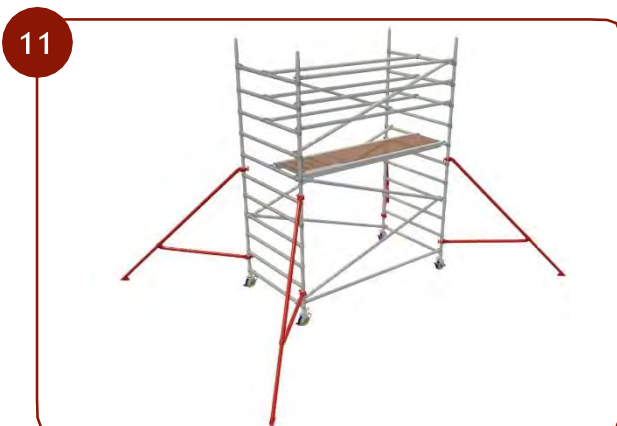

DOUBLE-WIDTH TOWER 6m

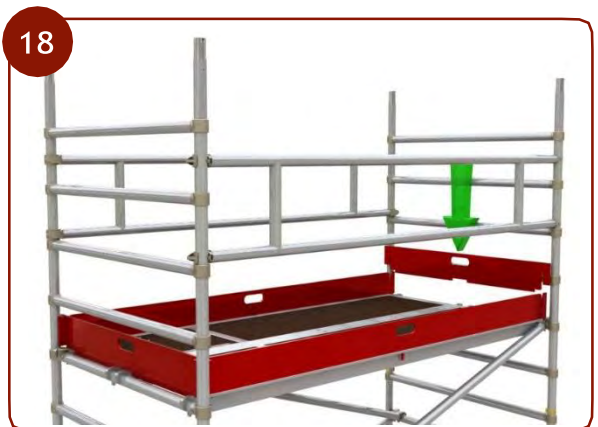

DOUBLE-WIDTH TOWER 6m

19



DOUBLE-WIDTH TOWER 5m

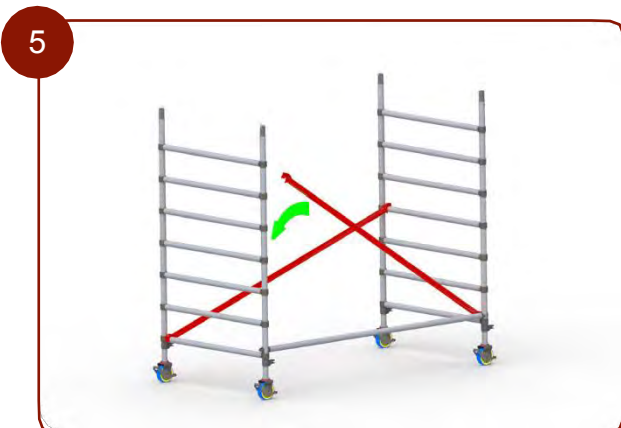
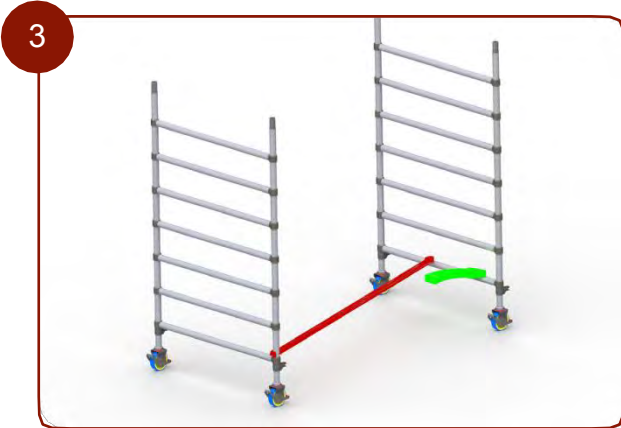
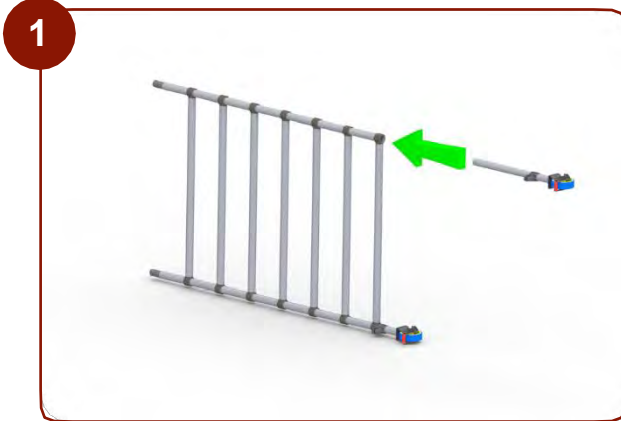

DOUBLE-WIDTH TOWER 5m

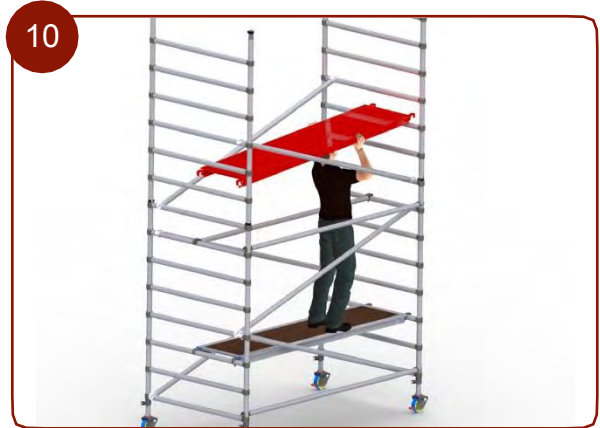
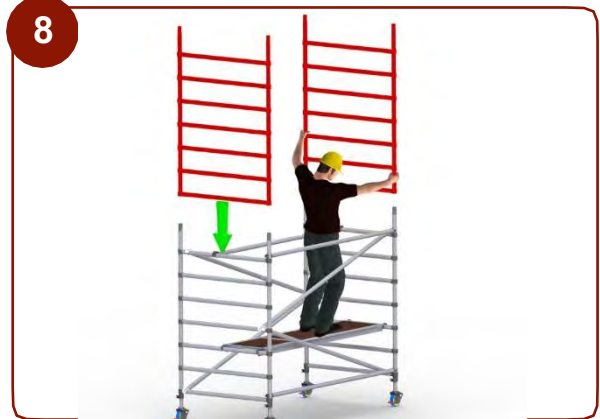
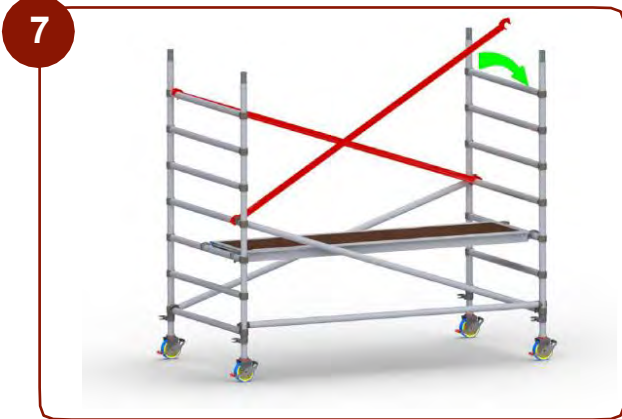

DOUBLE-WIDTH TOWER 5m

13



14



15



16



17

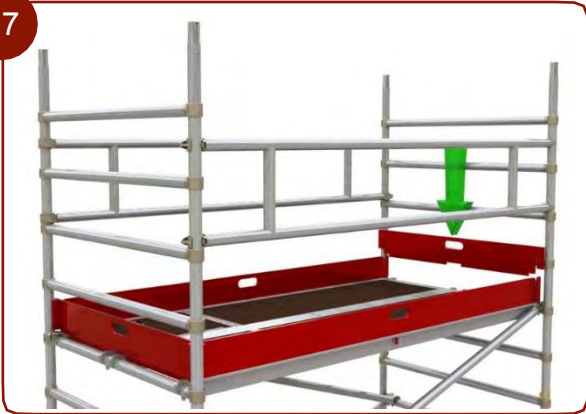

18



SPECIFIC PRODUCT INFORMATION

Table of parts and quantities

Note: Quoted platform heights included 150mm leg adjustment for levelling that can be increased or reduced

Span 300 Single Width Towers - 2m, 2.5m and 3m lengths to EN1004											
Platform Height (m)	1m	2m	3m	4m	5m	6m	7m	8m			
Work Height (m)	4	4	5	6	7	8	9	10			
Tower Height (m)	3	3	4	5	6	7	8	9			
Tower Weight in kg (2m in length) (SPAN300, 300W)	83	96	121	141	152	186	203	237			
Tower Weight in kg (2.5m in length) (SPAN300, 300W)	90	104	134	155	167	207	225	265			
Tower Weight in kg (3m in length) (SPAN300, 300W)	96	110	143	166	179	223	242	286			
Weight reduction (kg) for 300W Towers	6	9	11	14	17	20	22	26			
Description	Weight (kg)										
7 Rung Frame SPAN300 (300W)	8.5 (5.7)			2	2	4	4	6	6	8	8
4 Rung Frame SPAN300 (300W)	5.7 (4.1)				2		2		2		2
Trapdoor Platform (2, 2.5, 3m)	14	18	20	1	1	2	2	2	3	3	4
Horizontal Brace (2, 2.5, 3m)	1.7	2.0	2.4	1	1	3	7	9	13	15	19
Diagonal Brace (2, 2.5, 3m)	1.8	2.2	2.5	1	2	3	4	5	6	7	8
Bracing Frame (2, 2.5, 3m)	3.8	4.4	5.2	2	2	2	2	2	2	2	2
Telescopic Stabiliser (50430)	5.2			4	4	4	4	4	4		
Large Stabiliser (9090)	6.8									4	4
Adjustable Legs	1.1			4	4	4	4	4	4	4	4
Castor / Baseplate	2.2			4	4	4	4	4	4	4	4
Toe-board set (2, 2.5, 3m)	6.8	8.4	9.8	1	1	1	1	1	1	1	1

Exploded diagram & reference list

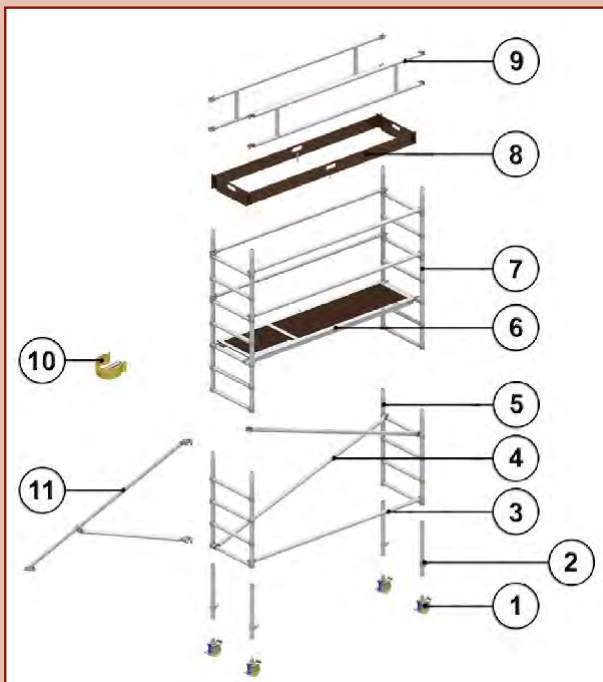

Tower Assembly

- 1. Castor
- 2. Adjustable Leg
- 3. Horizontal Brace
- 4. Diagonal Brace
- 5. 4 Rung Frame
- 6. Platform
- 7. 7 Rung Frame
- 8. Toeboard
- 9. Bracing Frame
- 10. Interlock Clip
- 11. Outrigger

SINGLE-WIDTH TOWER 6m - BUILD SEQUENCES SHOWN USING THE SPAN300 (300W IS SAME)

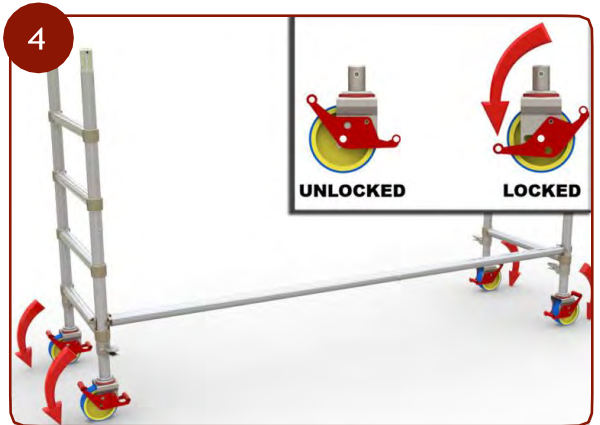
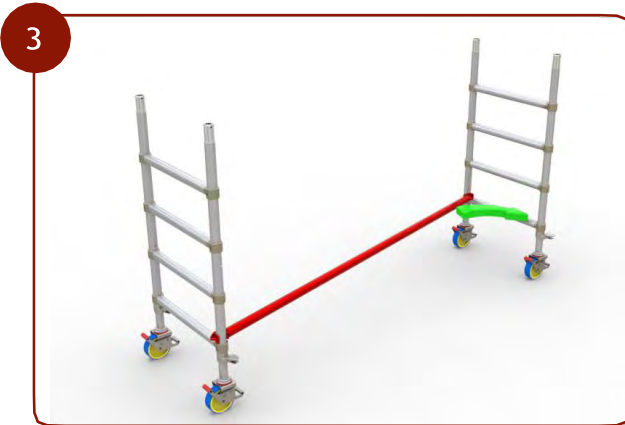
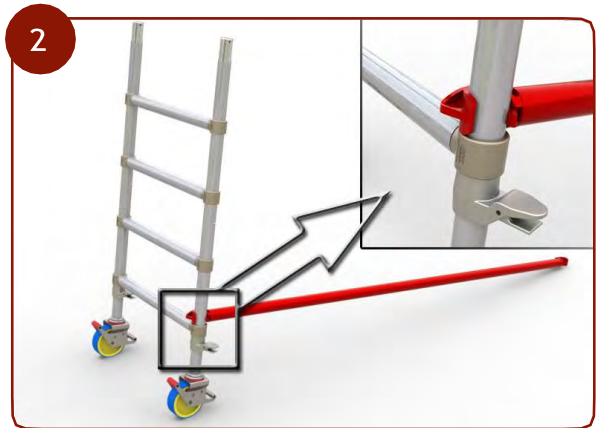
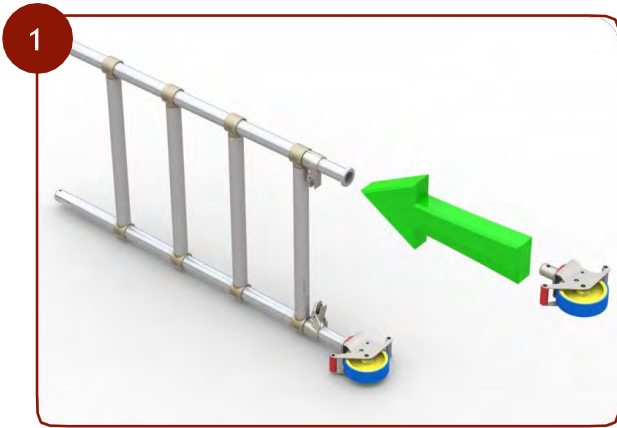

SINGLE-WIDTH TOWER 6m



SINGLE-WIDTH TOWER 6m

13



14



15



16



17



18



SINGLE-WIDTH TOWER 5m

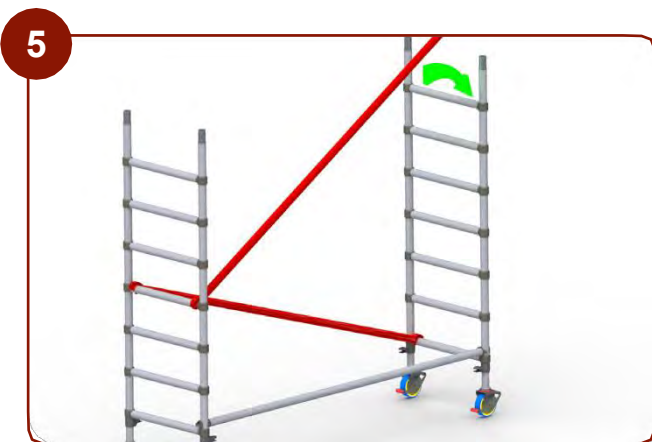
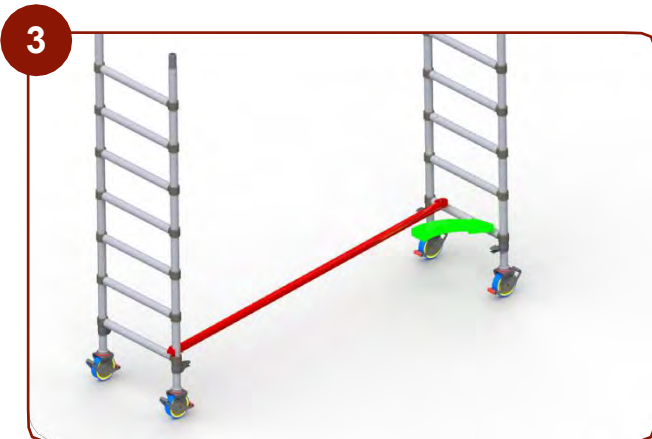
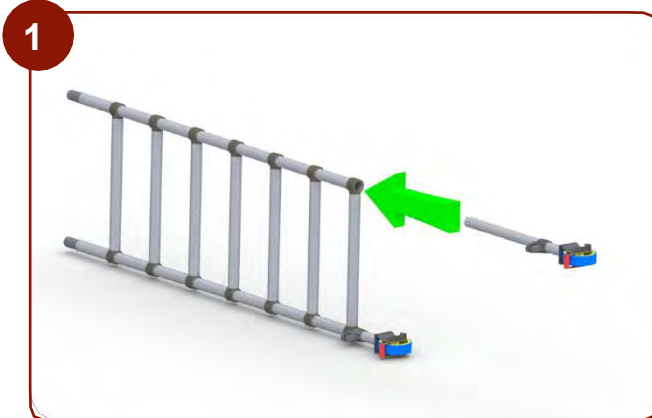

SINGLE-WIDTH TOWER 5m

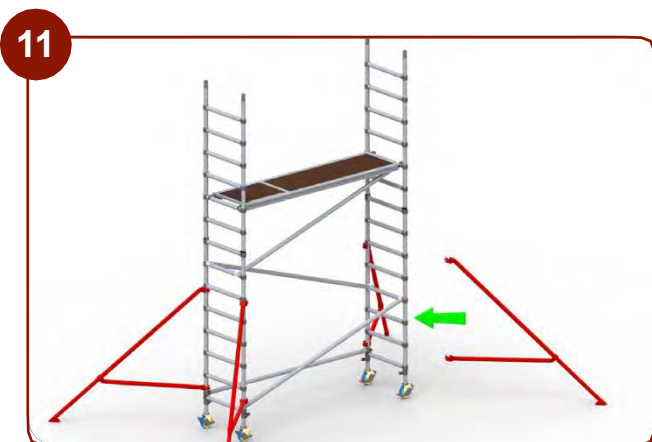

SINGLE-WIDTH TOWER 5m

13



14



15



16



17



18

