

INSTANT UPRIGHT

Tradie Instruction Manual



The Tradie is a mobile access tower system complying with EN 1004 and WAHR, designed for Class 3 loading. Check and observe all local / national regulations when using this product

This assembly instruction is designed to provide a step-by-step guide to ensure easy and safe erection using the 3T (Through The Trap) build method.

Read this guide and ensure understanding before starting assembly.

SAFE WORKING LOADS AND WORKING HEIGHTS

The safe working load at each level of platform is 200kg evenly distributed. The total loading on the tower structure should not exceed 400kg.

Maximum platform height is 7.1m

WARNING
NEVER STAND ON AN
UNGUARDED PLATFORM

ASSEMBLY PROCESS

1. Preparation

- Locate the tower level adjusters on each leg at 10cm (4 inches) from the bottom of the leg.
- Unlock the interlock clips on all frames.
- When installed, always move the interlock clip to the "locked" position.
- Sort the braces into horizontal and diagonal braces - the diagonals are slightly longer.
- Unlock the brace locks.



Unlocked



Locked



Unlocked



Locked

2. Removing fixed castor

Step 1: Loosen bolt inside castor by using a spanner

Step 2: Continue to loosen until the castor spigot can be removed from the upright tube.

Note:

Fixed castor only to be used for towers up to 1.9m platform.

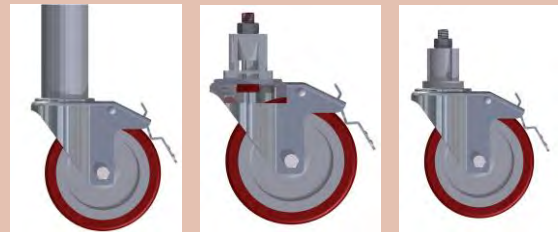

2. Base

Step 1: Install castor into adjustable leg.

Step 2: Ensure interlock clips are released from the base frames (bottom frames)..

Step 3: Install castor / leg assembly to frame by pushing the leg into the frame tube. This should be done with manual force only, without tools.

Step 4: Lock castors before ascending any part of the tower.

Step 5: Ensure the base is level before adding further components.

Note the locking and unlocking position for the castors as shown here.

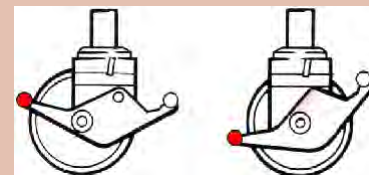

Unlocked

Locked

3. Locking down the platform (Windlock)

A windlock clip is installed on the platform at the hook. This is locked as shown here.



Unlocked



Locked

USAGE ADVICE

- We recommend a minimum of two people to assemble, dismantle and move the platform tower.
- Check that all components (including a spirit level and suitable rope for lifting as required) are on site and in good working order.
- Ensure that the assembly location is checked to prevent hazards during assembly, dismantling or moving and while working on the tower. Particular attention should be given to the ground condition, whether level or sloping, ensuring it is clear of obstructions and capable of supporting the tower structure. Wind conditions must be checked.
- Check that the tower is level (< 1 degree from vertical) by placing a level on a horizontal frame member and horizontal brace.
- Towers must always be climbed from the inside of the assembly using the horizontal rungs of the end frames
- Lifting of components must be done inside the effective base area of the tower; components are normally hoisted using a rope.
- Moving the tower must only be done by manual effect from the base of the tower.
- When moving tower be aware of overhead hazards (e.g. electric cables).
- No personnel or material to be on the platform whilst the tower is being moved.
- Beware of horizontal loads which can lead to instability of the tower. The maximum side force is 20kg.
- Do not use boxes or steps to gain additional height. If extra height required, contact your distributor to get extra components.
- Do not lift or suspend an assembled mobile tower.
- Damaged components or components from other tower systems must never be used.
- The correct stabilisers should always be fitted when specified, ensuring good contact is made between the stabiliser and the ground.
- When wind exceeds Beaufort force 4, cease using the tower.
- If wind is expected to reach Beaufort force 6, tie tower to a rigid structure.
- If winds of Force 8 are forecast, dismantle the tower or remove to shelter.
- Note that wind force can be greater around buildings, particularly at building corners and where the shape of the building could cause a 'tunnelling' effect such as open-ended or partially clad buildings.
- Before each use: ensure that the tower is complete, correctly assembled and vertical (adjust if necessary); ensure that environmental change has not influenced safe use.

Wind speeds				
Force	Peak mph	Peak km/h	Peak m/s	Guidance
4	18	29	8.1	Moderate breeze - raises dust & loose paper
6	31	50	13.9	Strong breeze - difficult to use umbrella
8	48	74	20.8	Gale force - walking is difficult

CARE AND MAINTENANCE

- Keep all equipment clean, especially spigots and sockets where frames join. Spigots should fit easily into sockets. Lubricate with light oil.
- Remove dirt or paint from adjustable legs with a light brush, lightly oil the leg locks.
- Do not strike or hammer components. Do not throw or drop onto hard surfaces.
- Lightly oil spring mechanism of the hooks.
- For transport and storage, components are best stored vertically.
- Damaged parts must be repaired or replaced; refer to the Instant Upright website for further advice or contact your equipment supplier for advice.
- Observe national regulations

STABILISERS

Stabilisers are to be used, when specified, to guarantee the structural stability of the tower.
Always ensure good stabiliser contact with the ground before climbing the tower.



x = 4360mm

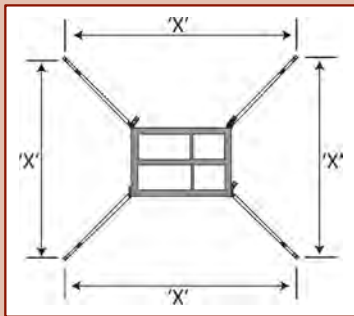

Fig 2



Fig 3



Fig 4

ALWAYS ENSURE STABILISER SIZE IS CORRECT AND ABLE TO SUPPORT TOWER

Lightly tighten the upper clamps above the sixth rung on each corner post. Position the lower clamp above the bottom rung. Ensure the lower arm is as horizontal as possible. Position the Stabilisers so that the footpads are approximately equidistant from each other, as shown in Fig.2. Adjust the outrigger and reposition the clamps as required to make firm contact with the ground. Ensure the clips with locking pin are in place. When in the correct position, tighten the clamps firmly.

To position the tower against a wall, do not remove the stabiliser; move parallel with the wall. (Fig.3)

To position the tower in a corner, remove the inside stabiliser and place the outside two parallel with the wall. (Fig.4)

VERTICAL DISTANCE BETWEEN LEVELS

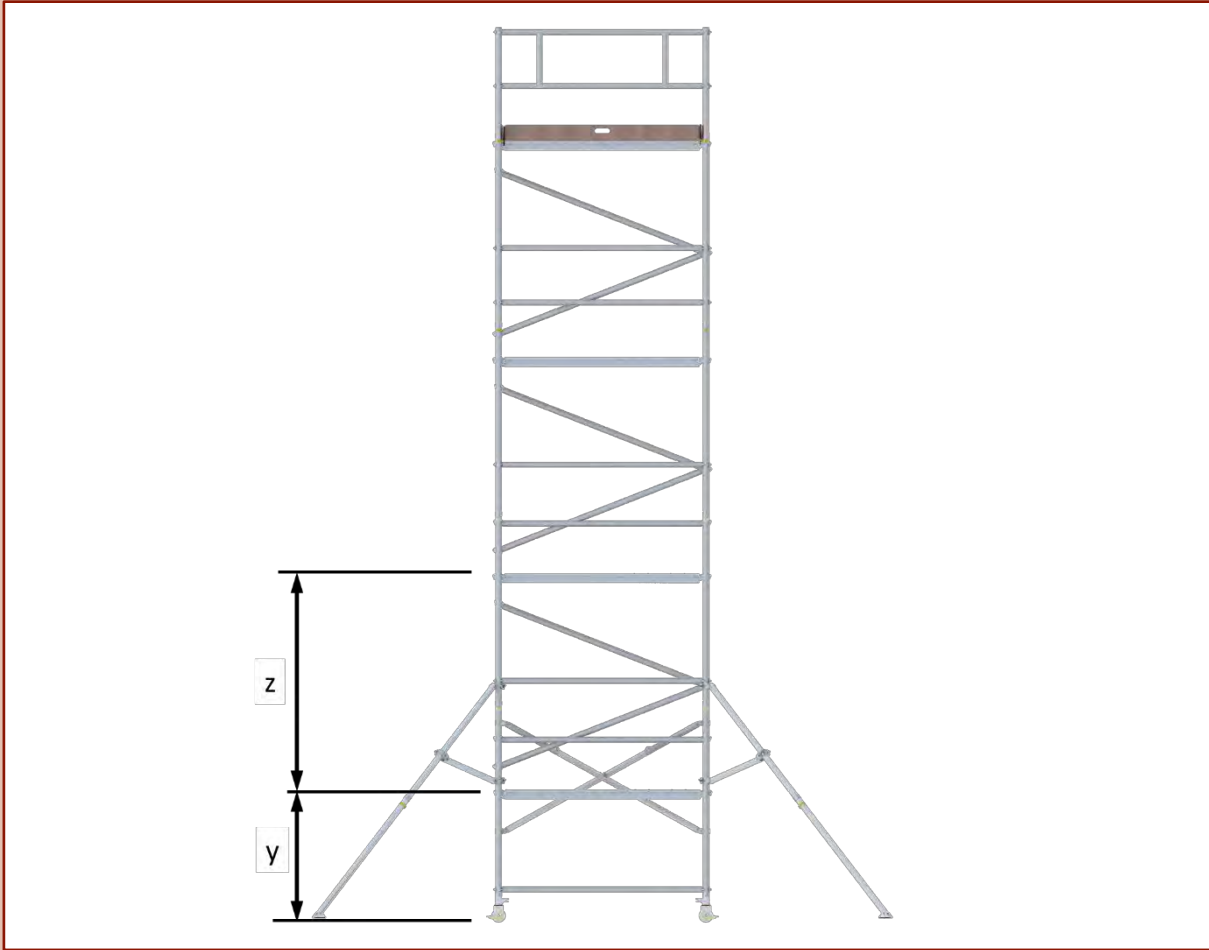

Top Platform Height	Distance between platforms	Distance from ground to first platform
0.9m	-	y = 0.65m
1.9m	-	y = 1.89m
2.6m	z = 2m	y = 0.89m
3.6m	z = 2m	y = 1.89m
5.4m	z = 2m	y = 1.59m
7.1m	z = 2m	y = 1.38m

Note, the stated distances from the ground to the first platform are based on the following:

- For towers ranging from 0.9m to 1.9m: 6" castor wheel.
- For towers ranging from 2.6m to 7.1m: 6" castor wheel with adjustable leg extended to 150mm.

SPECIFIC PRODUCT INFORMATION

Table of parts and quantities

TRADIE - 0.9m, 1.9m, 3.6m, 5.4m and 7.1m to EN1004 and WAHR						
Platform Height (m)	0.9m	1.9m	2.6m	3.6m	5.4m	7.1m
Work Height (m)	2.9m	3.8m	4.6m	5.6m	7.4m	9.1m
Tower Height (m)	2m	3m	3.7m	4.7m	6.4m	8.2m
Tower Weight (kg)	60.4kg	83.2kg	128kg	150.8kg	190.8kg	230.8kg

Description	Weight (kg)	Pack 1	Pack 2	Pack 3	Pack 4	Pack 5
Tradie base frame	27	1				
Horizontal brace	2	2		3	4	4
Diagonal brace	2.5			2	2	2
Trapdoor platform	15	1		1	1	1
Guardrail frame	2		2			
Mini Stabiliser	1.3	4				
Large Stabiliser	4			4		
Castor	2.3	4				
Castor & adjustable leg	3.4			4		
Toe-board set	6.8	*	1			
Extension Frame	6			2	2	2
Guardrail bracing frame	6		2			
	Pack Weight (kg)	60.4	22.8	67.6	40	40

* For platforms <1m, a risk analysis must be done before use to determine if additional *toe board or guard railing are required. Refer to national regulation.

Platform Height (m)					
0.9m	1.9m	2.6m	3.6m	5.4m	7.1m
Pack 1	Pack 1+2	Pack 1+3 ^	Pack 1+2+3	Pack 1+2+3+4	Pack 1+2+3+4+5

^ Purchase Toe-board set separately if required.

MOVING TOWER

To move the tower to a new position, first prepare the tower.

- Check that the wind speed does not exceed 29km/h (8.1m/s).
- Ensure the tower is empty (material and personnel)
- Check for overhead obstructions including electrical cables.
- Raise and stabiliser feet (only enough to clear obstructions).
- Taking care to ensure tower stability is maintained.
- Release the castor brakes.
- Carefully move the tower by manually applying force at the base. Do not use mechanical means to move the tower
- Once positioned prepare the tower for use.
- Check and adjust as necessary to ensure all castors and Stabilisers are in firm contact with the ground.
- Check that the tower is vertical (<1 degree from vertical) using a spirit level.
- Reapply the castor brakes.

TRADIE – 0.9m

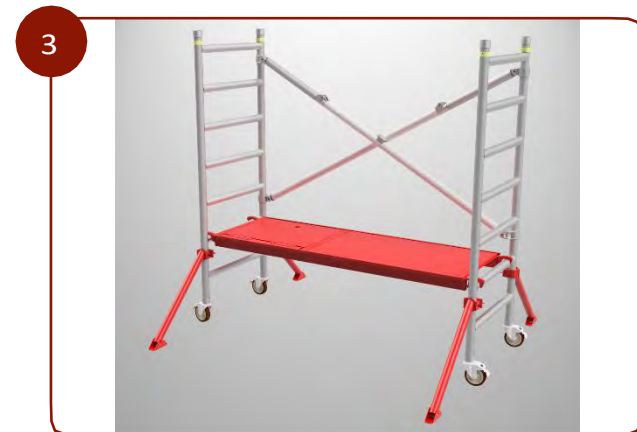
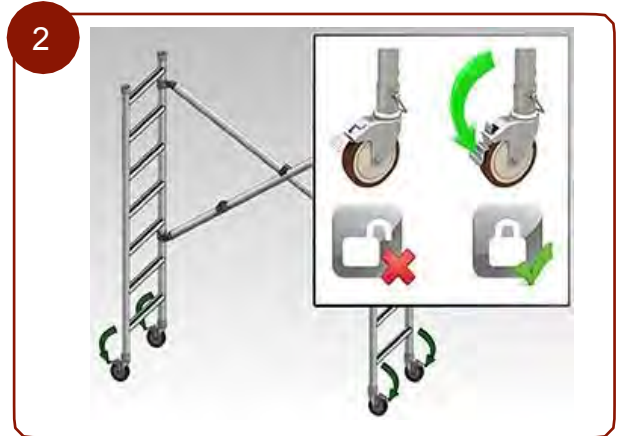

TRADIE - 1.9m

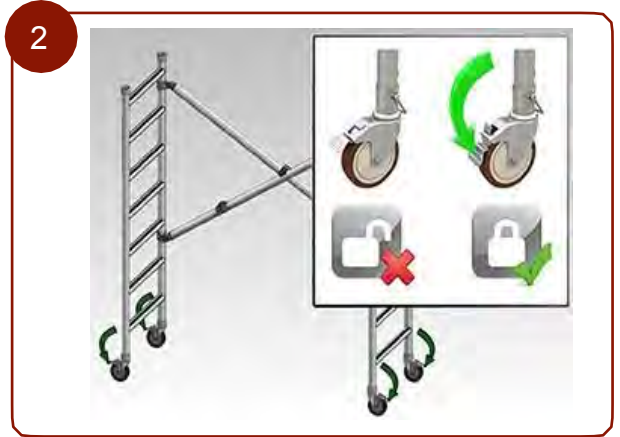
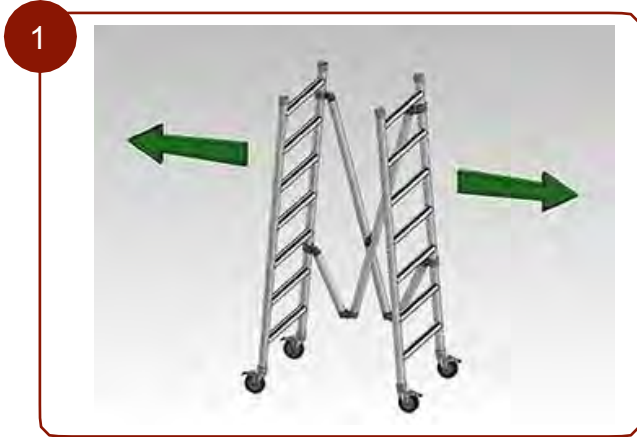

TRADIE - 2.6m

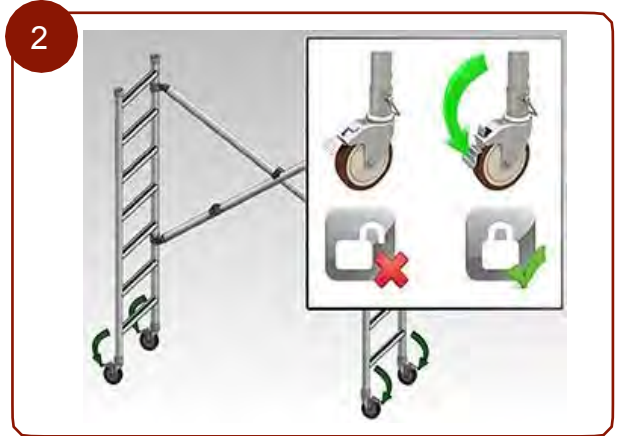

TRADIE - 2.6m

9



10



TRADIE - 3.6m

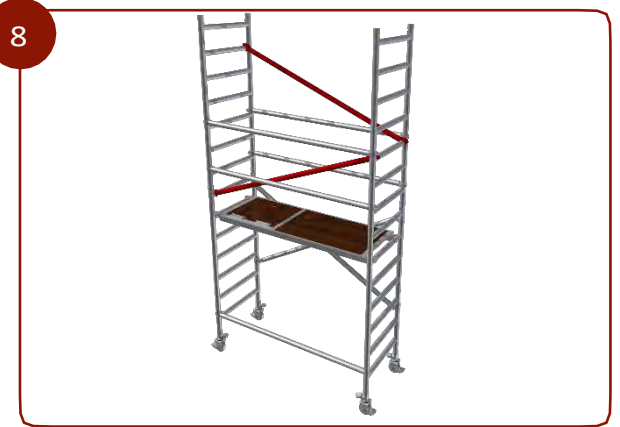
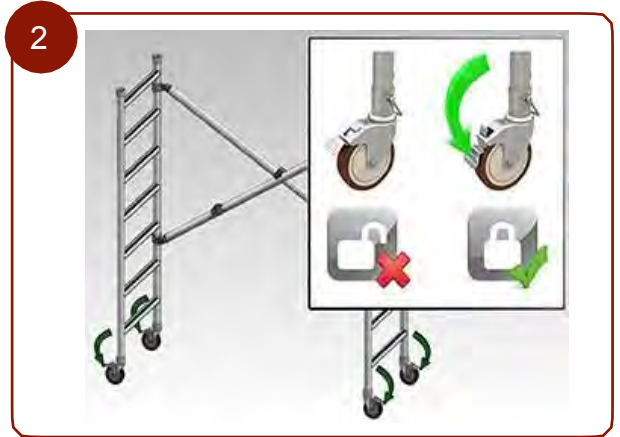
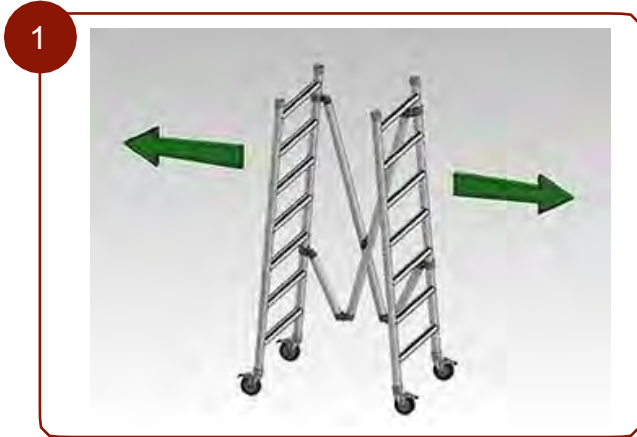

TRADIE - 3.6m continued

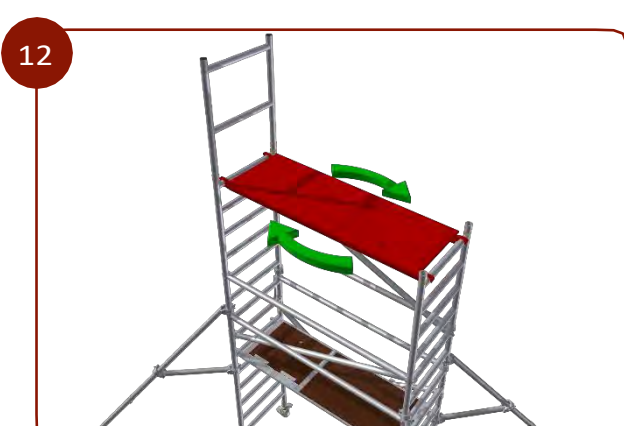

TRADIE - 5.4m

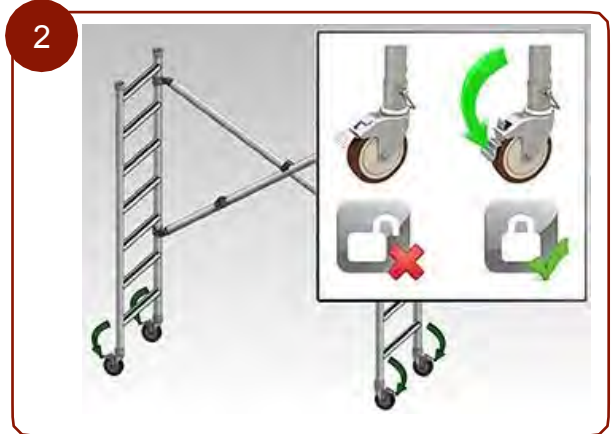

TRADIE - 5.4m continued

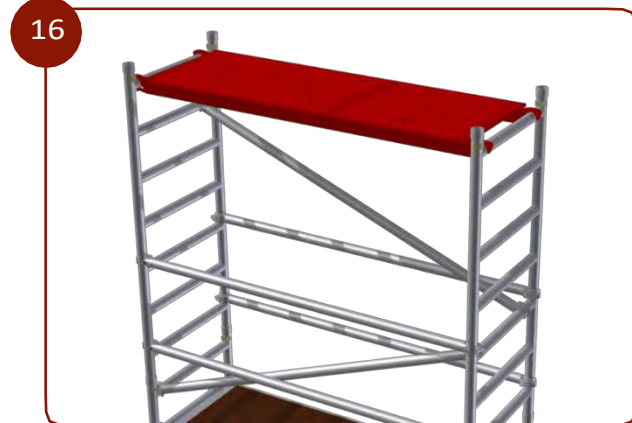
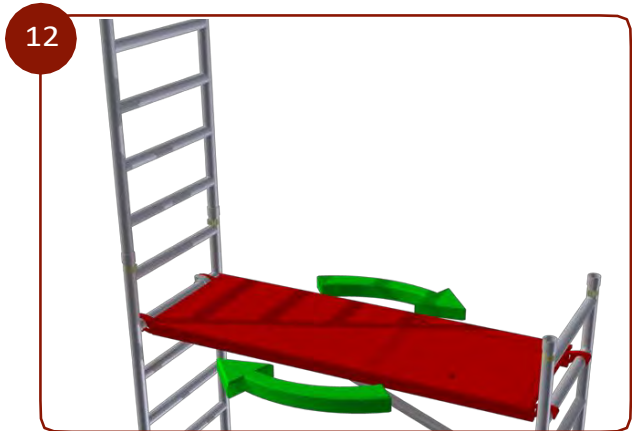
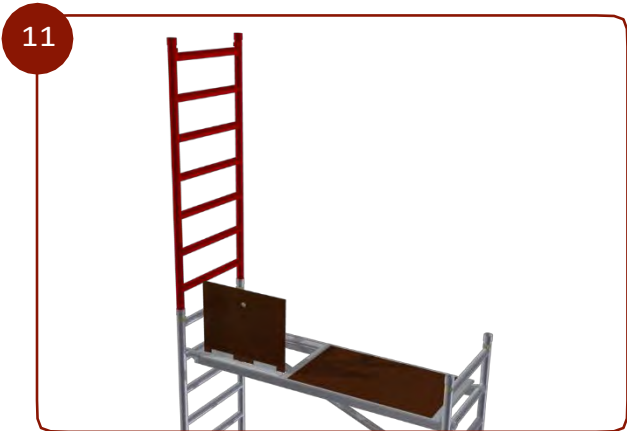

TRADIE - 5.4m continued

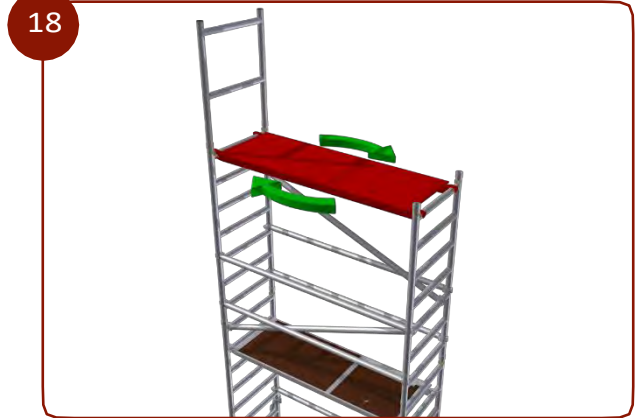

TRADIE - 7.1m

1

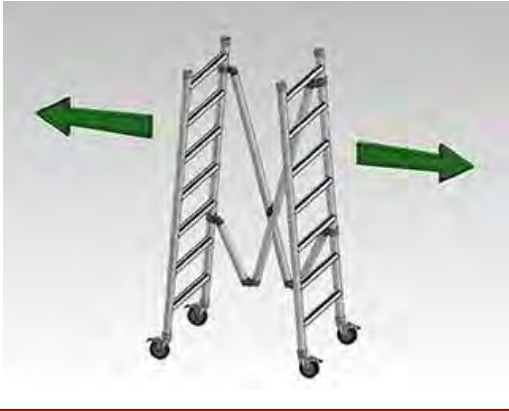

2

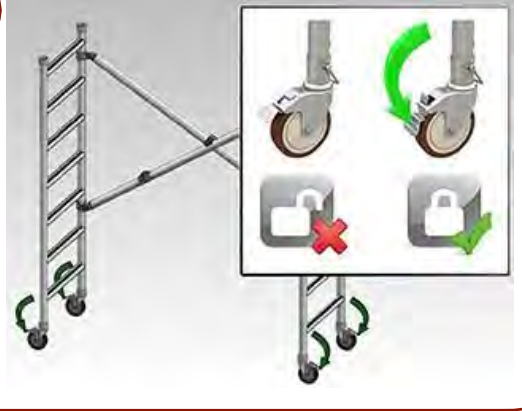

3



4



5



6



7

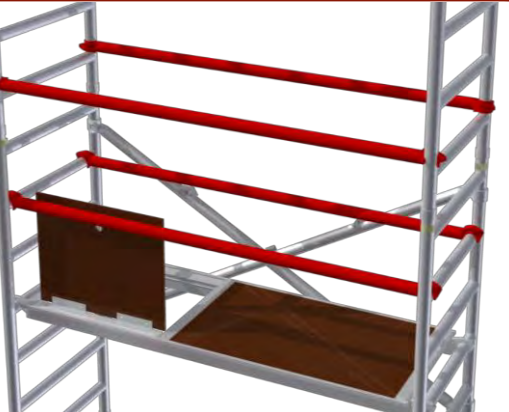

8



TRADIE - 7.1m continued

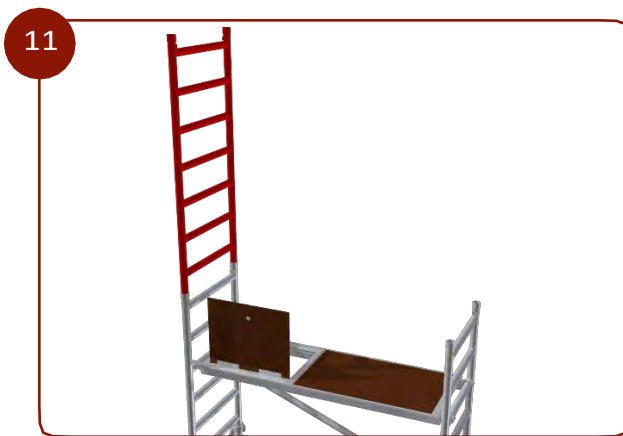

TRADIE - 7.1m continued

17



18



19



20



21



22



23



Instant Upright Dealer contact: